

# GV4PEM50S

Motor circuit breaker, TeSys GV4, 3P, 50A, Icu  
100kA, thermal magnetic multifunction, Everlink  
terminals





## Main

Range	TeSys
Product name	TeSys GV4
Device short name	GV4PEM
Product or component type	Multifunction circuit breaker
Device application	Motor protection
Protection type	Locked rotor Short time short-circuit protection Phase unbalance Jam Long start Overload Phase loss Ground fault protection Short-circuit
Utilisation category	Category A
Suitability for isolation	Yes conforming to IEC 60947-1
Poles description	3P
[Ue] rated operational voltage	690 V AC 50/60 Hz conforming to IEC 60947-2
[In] rated current	50 A
Trip unit technology	Electronic Thermal-magnetic
Magnetic tripping current	850 A
[I <sub>sd</sub> ] short-time pick-up adjustment range	5...13 x I <sub>r</sub>
Thermal protection adjustment range	20...50 A
Motor tripping class	10 20
Phase failure sensitivity	Yes conforming to IEC 60947-4-1
Breaking capacity	I <sub>cu</sub> 120 kA at 220...240 V AC 50/60 Hz conforming to IEC 60947-2 I <sub>cu</sub> 100 kA at 380...415 V AC 50/60 Hz conforming to IEC 60947-2 I <sub>cu</sub> 70 kA at 440 V AC 50/60 Hz conforming to IEC 60947-2 I <sub>cu</sub> 30 kA at 500 V AC 50/60 Hz conforming to IEC 60947-2 I <sub>cu</sub> 18 kA at 525 V AC 50/60 Hz conforming to IEC 60947-2 100 KA at 208Y/120 V AC 50/60 Hz conforming to UL 60947 100 KA at 240 V AC 50/60 Hz conforming to UL 60947 65 KA at 480Y/277 V AC 50/60 Hz conforming to UL 60947 I <sub>cu</sub> 10 kA at 660...690 V AC 50/60 Hz conforming to IEC 60947-2 25 kA at 600Y/347 V AC 50/60 Hz conforming to UL 60947
[I <sub>cs</sub> ] rated service breaking capacity	120 KA at 220...240 V AC 50/60 Hz conforming to IEC 60947-2 100 KA at 380...415 V AC 50/60 Hz conforming to IEC 60947-2 70 KA at 440 V AC 50/60 Hz conforming to IEC 60947-2 30 KA at 500 V AC 50/60 Hz conforming to IEC 60947-2 18 KA at 525 V AC 50/60 Hz conforming to IEC 60947-2 2.5 kA at 660...690 V AC 50/60 Hz conforming to IEC 60947-2
[U <sub>imp</sub> ] rated impulse withstand voltage	8 kV IEC 60947-2

[Ui] rated insulation voltage	800 V conforming to IEC 60947-2
Mechanical durability	40000 cycles
Electrical durability	20000 Cycles for AC-3 at 440 V In/2 10000 cycles for AC-3 at 440 V In

## Complementary

Motor power kW	11 KW at 400...415 V AC 50/60 Hz 15 KW at 500 V AC 50/60 Hz 18.5 KW at 660...690 V AC 50/60 Hz 15 KW at 400...415 V AC 50/60 Hz 18.5 KW at 400...415 V AC 50/60 Hz 22 KW at 400...415 V AC 50/60 Hz 18.5 KW at 500 V AC 50/60 Hz 22 KW at 500 V AC 50/60 Hz 30 KW at 500 V AC 50/60 Hz 22 KW at 660...690 V AC 50/60 Hz 30 KW at 660...690 V AC 50/60 Hz 37 KW at 660...690 V AC 50/60 Hz 45 kW at 660...690 V AC 50/60 Hz
Control type	Toggle
Handle padlocking	With a lock accessory
Number of slots	1 slot(s) for alarm switch for fault signalling contact, plug-in 1 slot(s) for voltage release for electrical remote tripping, plug-in 1 slot(s) for auxiliary switch for open/close contact, plug-in
Local signalling	Flashing LED (green)ready: LED (red)alarm (T° >95%): Green indicatorpresence of auxiliary contacts:
Communication port protocol	NFC
Standards	EN/IEC 60947-2 CSA C22.2 No 60947-4-1 UL 60947-4-1 EN/IEC 60947-4-1
Product certifications	IEC UL CSA CCC EAC ATEX EU-RO MR
Quality labels	CE
Mounting mode	By screws By clips
Mounting support	35 mm symmetrical DIN rail 75 mm symmetrical DIN rail Plate
Connections - terminals	Top 1 EverLink BTR screw connectors wire size 1.5...70 mm <sup>2</sup> , solid Top 1 EverLink BTR screw connectors wire size 1.5...50 mm <sup>2</sup> , flexible Bottom 1 EverLink BTR screw connectors wire size 2.5...95 mm <sup>2</sup> , solid Bottom 1 EverLink BTR screw connectors wire size 2.5...70 mm <sup>2</sup> , flexible
Connection pitch	27 mm
Wire stripping length	20 mm
Tightening torque	9 N.M for 16...95 mm <sup>2</sup> 5 N.m for 1.5...10 mm <sup>2</sup>
Width	81 mm
Height	155 mm
Depth	116 mm
Net weight	1.45 kg
Colour	Grey (RAL 7016)

## Environment

Ambient air temperature for storage	-50...85 °C
Ambient air temperature for operation	-25...70 °C
Operating altitude	0...2000 m without derating 2000...5000 m with derating
IP degree of protection	IP40 front face conforming to IEC 60529
IK degree of protection	IK07 conforming to IEC 62262
Pollution degree	3 conforming to IEC 60947-1
Tropicalisation	2 conforming to IEC 68-2
Mechanical robustness	Vibrations: +/- 1 mm 2...13.2 Hz conforming to IEC 60068-2-6 Vibrations: 0.7 gn 13.2...100 Hz conforming to IEC 60068-2-6 Shocks: 15 gn 11 ms conforming to IEC 60068-2-27

## Offer Sustainability

Sustainable offer status	Green Premium product
REACH Regulation	<a href="#">REACH Declaration</a>
EU RoHS Directive	Compliant <a href="#">EU RoHS Declaration</a>
Mercury free	Yes
RoHS exemption information	<a href="#">Yes</a>
China RoHS Regulation	<a href="#">China RoHS Declaration</a>
Environmental Disclosure	<a href="#">Product Environmental Profile</a>
Circularity Profile	<a href="#">End Of Life Information</a>
WEEE	The product must be disposed on European Union markets following specific waste collection and never end up in rubbish bins

## Contractual warranty

Warranty	18 months
----------	-----------

Thermal-Magnetic Tripping Curves for GV4P, GV4PE, GV4PEM

Average Operating Times at 20 °C Related to Multiples of the Setting Current

Hot state

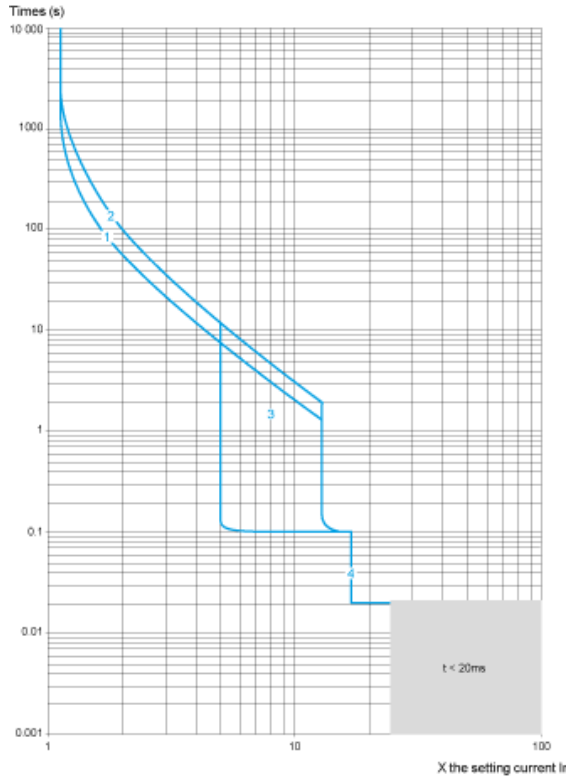

- 1 Class 10
- 2 Class 20
- 3  $I_{sd} = 5...13 \times I_r$
- 4  $I_{li} = 17 I_n$

## Cold state

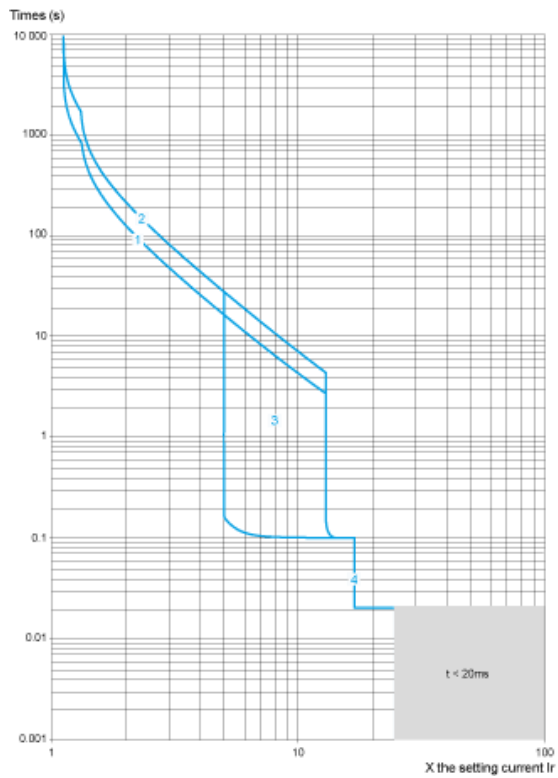

- 1 Class 10
- 2 Class 20
- 3  $I_{sd} = 5 \dots 13 \times I_r$
- 4  $I_i = 17 I_n$

## Current Limitation on Short-Circuit for GV4P, GV4PE, GV4PEM (3-Phase 400/415 V)

Dynamic Stress

$I_{\text{peak}} = f(\text{prospective } I_{sc}) \text{ at } 1.05 U_e = 435 \text{ V}$

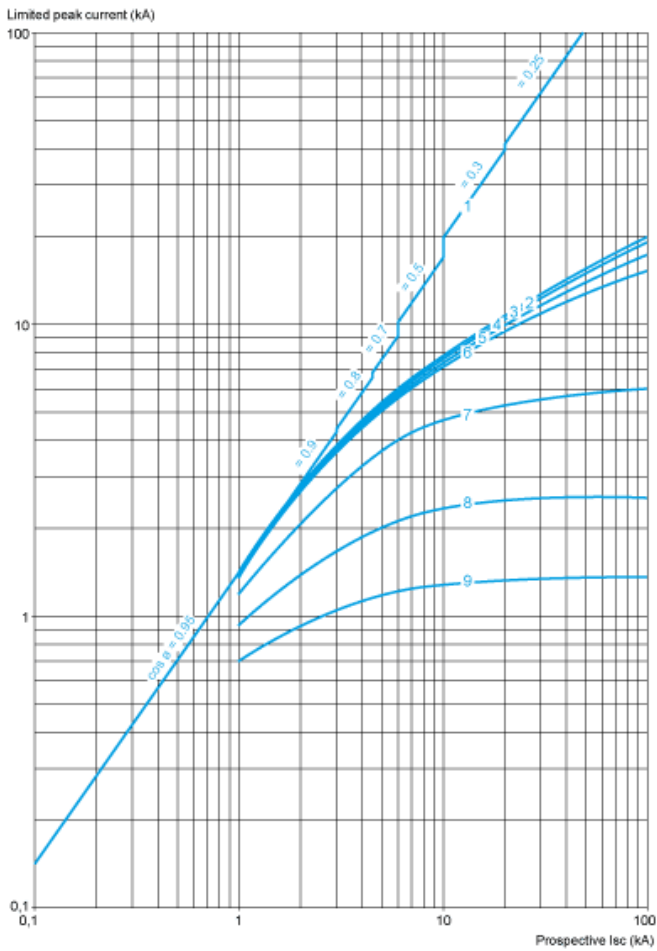

- 1 Maximum peak current
- 2 GV4P115
- 3 GV4P80
- 4 GV4P50
- 5 GV4P25
- 6 GV4P12
- 7 GV4P07
- 8 GV4P03
- 9 GV4P02

### Thermal Limit on Short-Circuit for GV4P, GV4PE, GV4PEM

Thermal Limit in  $kA^2s$  in the Magnetic Operating Zone

Sum of  $I^2dt = f$  (prospective Isc) at  $1.05 U_e = 435 V$

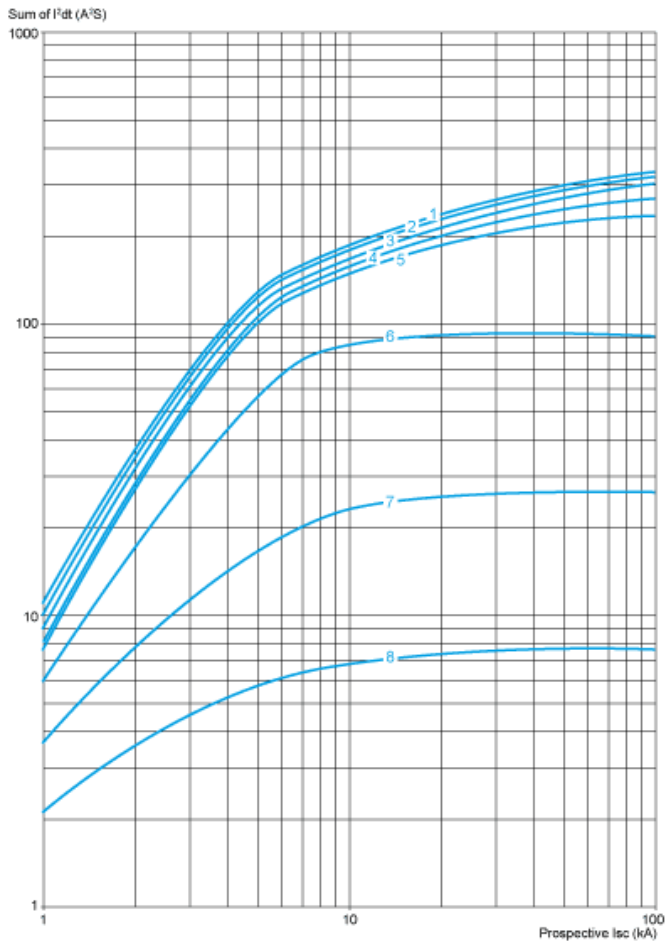

- 1 GV4P115
- 2 GV4P80
- 3 GV4P50
- 4 GV4P25
- 5 GV4P12
- 6 GV4P07
- 7 GV4P03
- 8 GV4P02



GV4 with Toggle: GV4LE, GV4PE, GV4PEM

With EverLink® Connector

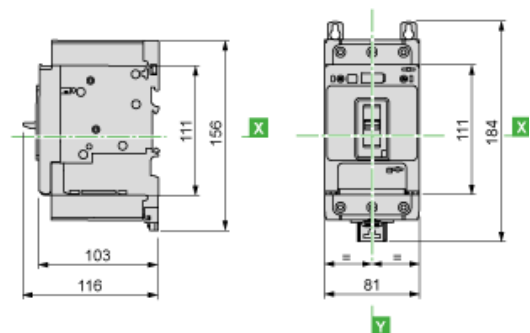

With Crimp Lug Connector

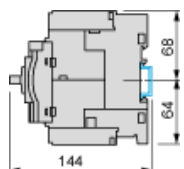

GV4 with Rotary Handle: GV4L, GV4P, or GV4LE, GV4PE, GV4PEM with GV4ADN01, GV4ADN02 Direct Mounting Rotary Handle

Dimensions

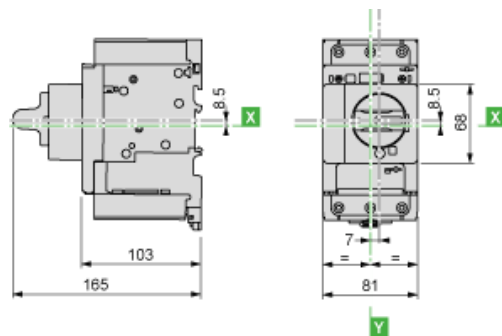

GV4L, GV4P, GV4LE, GV4PE, GV4PEM

Panel Mounting with M4 Screws

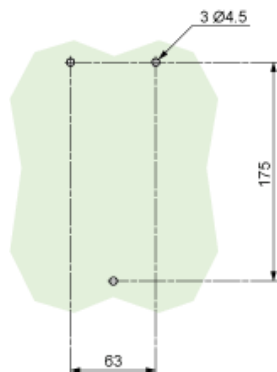

Door Cut-Out for Rotary Handle

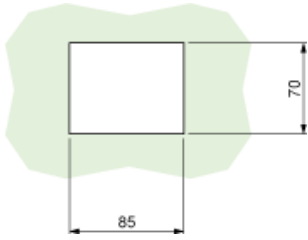

Minimum Safety Clearance

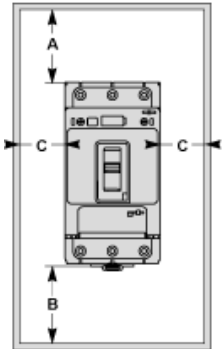

Toggle-type, rotary handle-type: identical clearance values.

Safety Clearance (mm)						
	Painted Sheet Metal			Bare Sheet Metal		
	A	B	C	A	B	C
No accessory	30	0	0	40	0	5
Interphase barriers	0	0	0	0	0	5
Long terminal shield	0	0	0	0	0	5

Magnetic Motor Circuit Breakers

GV4P, GV4PE, GV4PEM

