



### Main

Range of product	Harmony XB5
Product or component type	Head for non-illuminated push-button
Device short name	ZB5
Bezel material	Dark grey plastic
Mounting diameter	22 mm
Head type	Standard
Sale per indivisible quantity	1
Shape of signaling unit head	Round
Type of operator	Turn to release
Operator profile	Key switch
Type of keylock	Dom LU4
Key withdrawal position	Both positions
Locking position	Both positions

### Complementary

CAD overall width	29 mm
CAD overall height	29 mm
CAD overall depth	62 mm
Net weight	0.05 kg
Mechanical durability	500000 cycles
Station name	XALD 1...5 cut-outs XALK 2...5 cut-outs
Electrical composition code	C12 for <6 contacts using single blocks in front mounting C15 for <1 contacts using single blocks in front mounting SF1 for <3 contacts using single blocks in front mounting SR1 for <3 contacts using single blocks in rear mounting C13 for <6 contacts using single and double blocks in front mounting

### Environment

Protective treatment	TH
Ambient air temperature for storage	-40...70 °C
Ambient air temperature for operation	-25...70 °C
Electrical shock protection class	Class II conforming to IEC 60536
IP degree of protection	IP66 conforming to IEC 60529
NEMA degree of protection	NEMA 13 NEMA 4X
Resistance to high pressure washer	7000000 Pa at 55 °C, distance : 0.1 m
IK degree of protection	IK03 conforming to IEC 50102

The information provided in this documentation contains general descriptions and/or technical characteristics of the performance of the products contained herein. This documentation is not intended as a substitute for and is not to be used for determining suitability or reliability of these products for specific user applications. It is the duty of any such user or integrator to perform the appropriate and complete risk analysis, evaluation and testing of the products with respect to the relevant specific application or use thereof. Neither Schneider Electric Industries SAS nor any of its affiliates or subsidiaries shall be responsible or liable for misuse of the information contained herein.

Standards	UL 508 JIS C8201-5-1 EN/IEC 60947-1 CSA C22.2 No 14 EN/IEC 60947-5-1 EN/IEC 60947-5-5 EN/IEC 60947-5-4 JIS C8201-1
Product certifications	BV RINA UL listed DNV GL LROS (Lloyds register of shipping) CSA
Vibration resistance	5 gn (f= 2...500 Hz) conforming to IEC 60068-2-6
Shock resistance	30 gn (duration = 18 ms) for half sine wave acceleration conforming to IEC 60068-2-27 50 gn (duration = 11 ms) for half sine wave acceleration conforming to IEC 60068-2-27

### Offer Sustainability

Sustainable offer status	Green Premium product
REACH Regulation	<a href="#">REACH Declaration</a>
REACH free of SVHC	Yes
EU RoHS Directive	Pro-active compliance (Product out of EU RoHS legal scope) <a href="#">EU RoHS Declaration</a>
Toxic heavy metal free	Yes
Mercury free	Yes
RoHS exemption information	<a href="#">Yes</a>
China RoHS Regulation	<a href="#">China RoHS Declaration</a>
Environmental Disclosure	<a href="#">Product Environmental Profile</a>
Circularity Profile	<a href="#">End Of Life Information</a>

### Contractual warranty

Warranty	18 months
----------	-----------

Dimensions

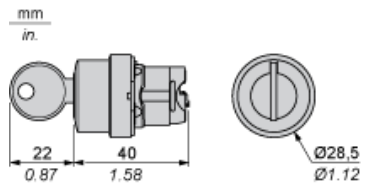

Panel Cut-out for Pushbuttons, Switches and Pilot Lights (Finished Holes, Ready for Installation)

Connection by Screw Clamp Terminals or Plug-in Connectors or on Printed Circuit Board

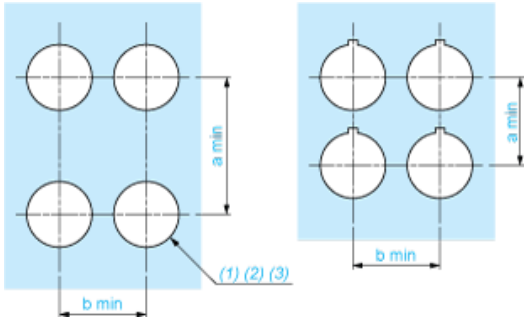

- (1) Diameter on finished panel or support
- (2) For selector switches and Emergency stop buttons, use of an anti-rotation plate type ZB5AZ902 is recommended.
- (3)  $\varnothing 22.5$  mm recommended ( $\varnothing 22.3 \text{ }_0^{+0.4}$ ) /  $\varnothing 0.89$  in. recommended ( $\varnothing 0.88 \text{ in. }_0^{+0.016}$ )

Connections	a in mm	a in in.	b in mm	b in in.
By screw clamp terminals or plug-in connector	40	1.57	30	1.18
By Faston connectors	45	1.77	32	1.26
On printed circuit board	30	1.18	30	1.18

Detail of Lug Recess

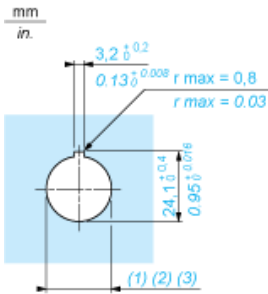

- (1) Diameter on finished panel or support
- (2) For selector switches and Emergency stop buttons, use of an anti-rotation plate type ZB5AZ902 is recommended.
- (3)  $\varnothing 22.5$  mm recommended ( $\varnothing 22.3 \text{ }_0^{+0.4}$ ) /  $\varnothing 0.89$  in. recommended ( $\varnothing 0.88 \text{ in. }_0^{+0.016}$ )

Pushbuttons, Switches and Pilot Lights for Printed Circuit Board Connection

### Panel Cut-outs (Viewed from Installer's Side)

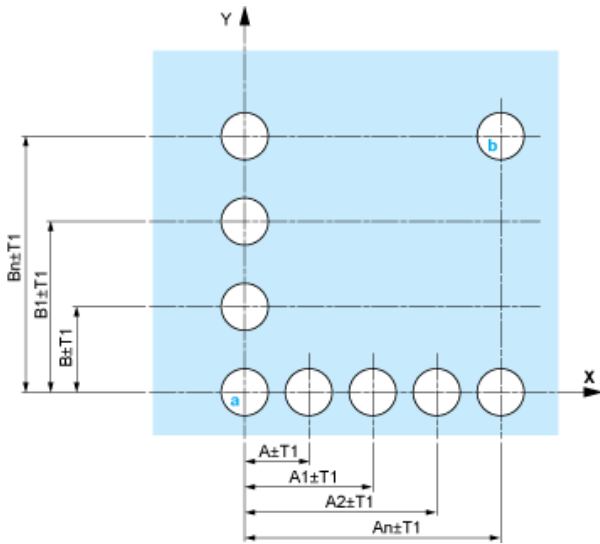

- A: 30 mm min. / 1.18 in. min.
- B: 40 mm min. / 1.57 in. min.

### Printed Circuit Board Cut-outs (Viewed from Electrical Block Side)

Dimensions in mm

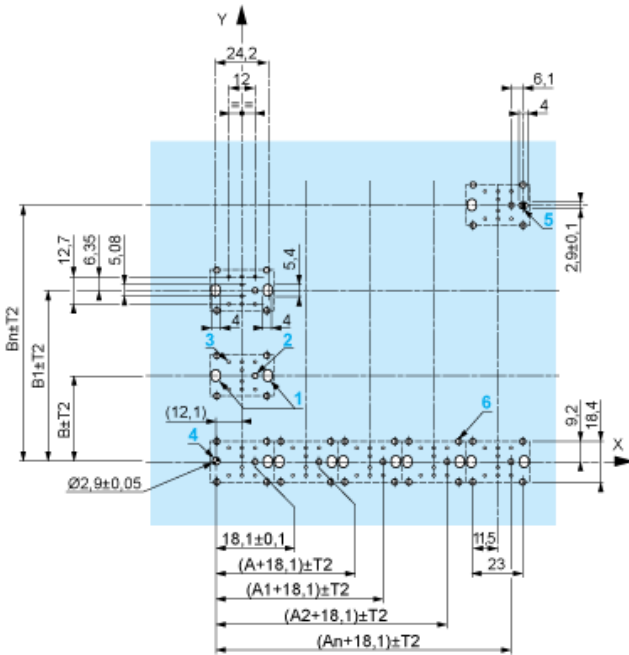

- A: 30 mm min.
- B: 40 mm min.

Dimensions in in.



- A: 1.18 in. min.
- B: 1.57 in. min.

### General Tolerances of the Panel and Printed Circuit Board

The cumulative tolerance must not exceed 0.3 mm / 0.012 in.: T1 + T2 = 0.3 mm max.

### Installation Precautions

- Minimum thickness of circuit board: 1.6 mm / 0.06 in.
- Cut-out diameter: 22.4 mm ± 0.1 / 0.88 in. ± 0.004
- Orientation of body/fixing collar ZB5AZ009: ± 2° 30' (excluding cut-outs marked a and b).
- Tightening torque of screws ZBZ006: 0.6 N.m (5.3 lbf.in) max.
- Allow for one ZB5AZ079 fixing collar/pillar and its fixing screws:
  - every 90 mm / 3.54 in. horizontally (X), and 120 mm / 4.72 in. vertically (Y).
  - with each selector switch head (ZB5AD\*, ZB5AJ\*, ZB5AG\*).

The fixing centers marked a and b are diagonally opposed and must align with those marked 4 and 5.



- (1) Head ZB5AD\*
- (2) Panel
- (2) Nut
- (4) Printed circuit board

## Mounting of Adapter (Socket) ZBZ01•

- 1 2 elongated holes for ZBZ006 screw access
- 2 1 hole  $\varnothing$  2.4 mm  $\pm$  0.05 / 0.09 in.  $\pm$  0.002 for centring adapter ZBZ01•
- 3 8  $\times$   $\varnothing$  1.2 mm / 0.05 in. holes
- 4 1 hole  $\varnothing$  2.9 mm  $\pm$  0.05 / 0.11 in.  $\pm$  0.002, for aligning the printed circuit board (with cut-out marked a)
- 5 1 elongated hole for aligning the printed circuit board (with cut-out marked b)
- 6 4 holes  $\varnothing$  2.4 mm / 0.09 in. for clipping in adapter ZBZ01•

Dimensions An + 18.1 relate to the  $\varnothing$  2.4 mm  $\pm$  0.05 / 0.09 in.  $\pm$  0.002 holes for centring adapter ZBZ01•.

---

Electrical Composition Corresponding to Code C12

---



---

Electrical Composition Corresponding to Code C13

---



---

Electrical Composition Corresponding to Code C15

---

1 N/O

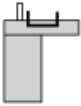

1 N/C



1 N/O + N/C or 1 N/O + N/O or 1 N/C + N/C

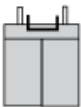

---

Electrical Composition Corresponding to Codes C9, C11, SF1 and SR1

---



---

Legend

---

Single contact





Double contact



Light block



Possible location

