



Main

Range of product	Modicon TM3
Product or component type	Analog input module
Range compatibility	Modicon M221 Modicon M241 Modicon M251 Modicon M262
Analogue input number	4
Analogue input type	Current 4...20 mA Current 0...20 mA Voltage 0...10 V Voltage - 10...10 V Thermocouple - 200...1000 °C with thermocouple J Thermocouple - 200...1300 °C with thermocouple K Thermocouple 0...1760 °C with thermocouple R Thermocouple 0...1760 °C with thermocouple S Thermocouple 0...1820 °C with thermocouple B Thermocouple - 200...400 °C with thermocouple T Thermocouple - 200...1300 °C with thermocouple N Thermocouple - 200...800 °C with thermocouple E Thermocouple 0...2315 °C with thermocouple C Pt 100 temperature probe - 200...850 °C Pt 1000 temperature probe - 200...600 °C

Complementary

Analogue input resolution	16 bits 15 bits + sign
Permissible continuous overload	13 V, analogue input type: voltage 40 mA, analogue input type: current
Input impedance	<= 50 Ohm current >= 1 MOhm voltage >= 1 MOhm thermocouple >= 1 MOhm temperature probe
LSB value	2.44 mV 0...10 Vvoltage 4.88 mV - 10...10 Vvoltage 4.88 µA 0...20 mAcurrent 3.91 µA 4...20 mAcurrent 0.1 °Ctemperature probe 0.1 °Cthermocouple
Conversion time	100 ms + 100 ms per channel + 1 controller cycle time for analogue input thermocouple 100 ms + 100 ms per channel + 1 controller cycle time for analogue input temperature probe 10 ms + 10 ms per channel + 1 controller cycle time for analogue input voltage/current
Sampling duration	10 Ms, analogue input type: voltage/current 100 Ms, analogue input type: voltage/current 100 Ms, analogue input type: thermocouple 100 ms, analogue input type: temperature probe

The information provided in this documentation contains general descriptions and/or technical characteristics of the performance of the products contained herein. This documentation is not intended as a substitute for and is not to be used for determining suitability or reliability of these products for specific user applications. It is the duty of any such user or integrator to perform the appropriate and complete risk analysis, evaluation and testing of the products with respect to the relevant specific application or use thereof. Neither Schneider Electric Industries SAS nor any of its affiliates or subsidiaries shall be responsible or liable for misuse of the information contained herein.

Absolute accuracy error	+/- 0.2 % of full scale at 25 °C for analogue input voltage/current +/- 0.2 % of full scale at 25 °C for Pt 100/Pt 1000, Ni 100/ Ni 1000 temperature probe +/- 0.2 % of full scale at 25 °C for thermocouple C 0...2315 °C +/- 6 °C at 25 °C for thermocouple R, S 0...200 °C +/- 0.2 % of full scale at 25 °C for thermocouple R, S 200...1760 °C +/- 0.2 % of full scale at 25 °C for thermocouple B 300...1820 °C +/- 0.4 % of full scale at 25 °C for thermocouple K - 200...0 °C +/- 0.2 % of full scale at 25 °C for thermocouple K 0...1300 °C +/- 0.4 % of full scale at 25 °C for thermocouple J - 200...0 °C +/- 0.2 % of full scale at 25 °C for thermocouple J 0...1000 °C +/- 0.4 % of full scale at 25 °C for thermocouple E - 200...0 °C +/- 0.2 % of full scale at 25 °C for thermocouple E 0...800 °C +/- 0.4 % of full scale at 25 °C for thermocouple T - 200...0 °C +/- 0.2 % of full scale at 25 °C for thermocouple T 0...400 °C +/- 0.4 % of full scale at 25 °C for thermocouple N - 200...0 °C +/- 0.2 % of full scale at 25 °C for thermocouple N 0...1300 °C
Temperature drift	+/- 0.01 %FS/°C
Repeat accuracy	+/-0.5 %FS
Non-linearity	+/- 0.2 %FS
Cross talk	<= 1 LSB
[Us] rated supply voltage	24 V DC
Supply voltage limits	20.4...28.8 V
Type of cable	Twisted shielded pairs cable <30 m for input circuit
Current consumption	45 mA at 5 V DC via bus connector 50 mA at 5 V DC via bus connector 35 mA at 24 V DC via external supply 40 mA at 24 V DC via external supply
Local signalling	1 LED (green) for PWR
Electrical connection	10 x 1.5 mm ² removable screw terminal block with pitch 3.81 mm adjustment for inputs and supply 10 x 1.5 mm ² removable screw terminal block with pitch 3.81 mm adjustment for inputs
Insulation	Between input and supply at 1500 V AC Between input and internal logic at 500 V AC
Marking	CE
Surge withstand	1 KV power supply common mode conforming to EN/IEC 61000-4-5 0.5 KV power supply differential mode conforming to EN/IEC 61000-4-5 1 kV input common mode conforming to EN/IEC 61000-4-5
Mounting support	Top hat type TH35-15 rail conforming to IEC 60715 Top hat type TH35-7.5 rail conforming to IEC 60715 Plate or panel with fixing kit
Height	90 mm
Depth	70 mm
Width	23.6 mm
Net weight	0.1 kg

Environment

Standards	EN/IEC 61131-2 EN/IEC 61010-2-201
Resistance to electrostatic discharge	8 KV in air conforming to EN/IEC 61000-4-2 4 kV on contact conforming to EN/IEC 61000-4-2
Resistance to electromagnetic fields	10 V/M 80 MHz...1 GHz conforming to EN/IEC 61000-4-3 3 V/M 1.4 GHz...2 GHz conforming to EN/IEC 61000-4-3 1 V/m 2 GHz...3 GHz conforming to EN/IEC 61000-4-3
Resistance to magnetic fields	30 A/m conforming to EN/IEC 61000-4-8
Resistance to fast transients	1 kV (I/O) conforming to EN/IEC 61000-4-4
Resistance to conducted disturbances	10 V 0.15...80 MHz conforming to EN/IEC 61000-4-6 3 V spot frequency (2, 3, 4, 6.2, 8.2, 12.6, 16.5, 18.8, 22, 25 MHz) conforming to Marine specification (LR, ABS, DNV, GL)
Electromagnetic emission	Radiated emissions - test level: 40 dBµV/m QP class A (10 m) at 30...230 MHz conforming to EN/IEC 55011 Radiated emissions - test level: 47 dBµV/m QP class A (10 m) at 230...1000 MHz conforming to EN/IEC 55011
Immunity to microbreaks	10 ms
Ambient air temperature for operation	-10...55 °C horizontal installation -10...35 °C vertical installation

Ambient air temperature for storage	-25...70 °C
Relative humidity	10...95 %, without condensation (in operation) 10...95 %, without condensation (in storage)
IP degree of protection	IP20
Pollution degree	2
Operating altitude	0...2000 m
Storage altitude	0...3000 m
Vibration resistance	3.5 mm at 5...8.4 Hz on DIN rail 3 gn at 8.4...150 Hz on DIN rail
Shock resistance	15 gn for 11 ms

Packing Units

Unit Type of Package 1	PCE
Number of Units in Package 1	1
Package 1 Weight	201.0 g
Package 1 Height	7.5 cm
Package 1 width	12.5 cm
Package 1 Length	10.5 cm
Unit Type of Package 2	S02
Number of Units in Package 2	9
Package 2 Weight	2.273 kg
Package 2 Height	15 cm
Package 2 width	30 cm
Package 2 Length	40 cm

Offer Sustainability

Sustainable offer status	Green Premium product
REACH Regulation	REACH Declaration
EU RoHS Directive	Pro-active compliance (Product out of EU RoHS legal scope) EU RoHS Declaration
Toxic heavy metal free	Yes
Mercury free	Yes
RoHS exemption information	Yes
China RoHS Regulation	China RoHS Declaration
Environmental Disclosure	Product Environmental Profile
Circularity Profile	End Of Life Information
WEEE	The product must be disposed on European Union markets following specific waste collection and never end up in rubbish bins
PVC free	Yes
California proposition 65	WARNING: This product can expose you to chemicals including: Lead and lead compounds, which is known to the State of California to cause cancer and birth defects or other reproductive harm. For more information go to www.P65Warnings.ca.gov

Dimensions

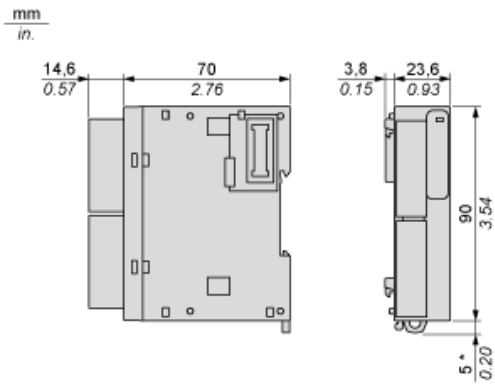

(*) 8.5 mm/0.33 in when the clamp is pulled out.

Spacing Requirements

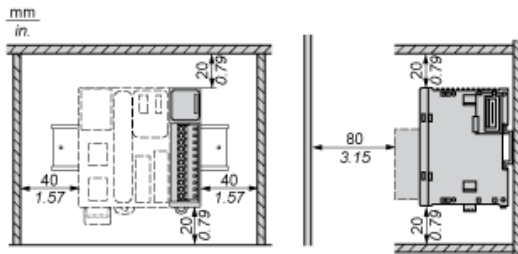

Mounting on a Rail



Incorrect Mounting

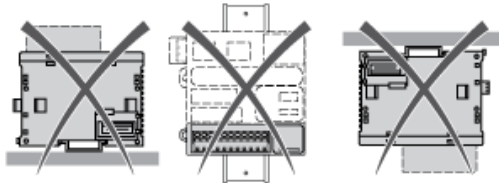

Mounting on a Panel Surface



(1) Install a mounting strip

Mounting Hole Layout

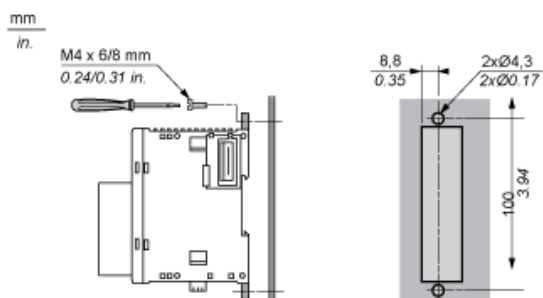

Analogue Input Module

Wiring Diagram (Current/Voltage type)

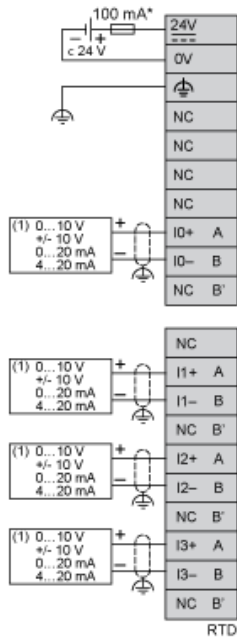

- (*) Type T fuse
- (1) Current/Voltage analog output device

Wiring Diagram (Thermocouple input type)

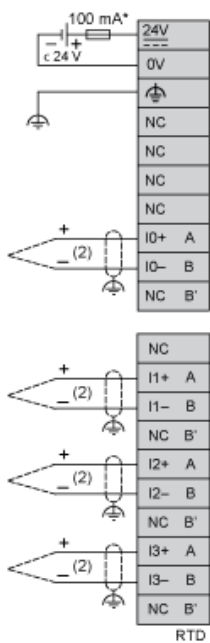

- (*) Type T fuse
- (2) Thermocouple

Wiring Diagram (Temperature probe input type)

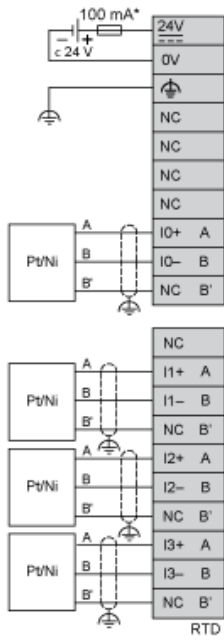

(*) Type T fuse