



Teknisk informasjon

Produktspekter	Harmony XB5
Produkt eller type komponent	Hode for lystrykknapper
Kortnavn utstyr	ZB5
Produktkompatibilitet	Universal LED
Innfatningsmateriale	Dark grey plastic
Montasjediameter	22 mm
Salg per udelelig kvantitet	1
Hode type	Standard
Formen på varslingsenhetens hode	Rund
Type arm/stempel	fjærretur
Operatørprofil	Hvit innfelt, umerket
Knappens tilleggs info.	Klar beskyttelseshette

Komplementær

Bredde	30 mm
Høyde	30 mm
Dybde	37 mm
Vekt	0,019 kg
Resistens til høytrykksvask	7000000 Pa på 55 °C, distanse : 0.1 m
Mekanisk levetid	10000000 sykluser
Hovedgruppe	Lystrykknapp
Gruppe av produktet	Flat trykknapp med integral LED
Stasjonsnavn	XALD 1...5 hull XALK 2...5 hull
Hette eller deksselfarge	Hvit
Merking	Umerket
Elektrisk sammensetningskode	M1 for <6 kontakter bruker Enkel blokker i frontmontering med innebygget LED M2 for <6 kontakter bruker enkel og dobbel blokker i frontmontering med innebygget LED M6 for <2 kontakter bruker Enkel blokker i frontmontering med integrert LED og transformator M10 for <2 kontakter bruker Enkel blokker i frontmontering med innebygget LED MF1 for <2 kontakter bruker Enkel blokker i frontmontering med innebygget LED MR1 for <2 kontakter bruker Enkel blokker i bakmontering med innebygget LED
Enhetens utseende	Basic sub-assemblies

Miljø

Overflatebeskyttelse	TC
Omgivelsestemperatur for lagring	-40...70 °C
Omgivelsestemperatur drift	-40...70 °C
Overspenningskategori	Klasse II i samsvar med IEC 60536
IP-grad	IP66 i samsvar med IEC 60529 IP67
NEMA beskyttelsesgrad	NEMA 13 NEMA 4X
IK beskyttelsesklasse	IK05 i samsvar med EN 50102

Standarder	UL 508 CSA C22.2 No 14 EN/IEC 60947-5-1 EN/IEC 60947-5-4 EN/IEC 60947-1 GB 14048.5 JIS C8201-5-1 JIS C8201-1
Produktsertifikater	GL LROS (Lloyds register of shipping) UL listet BV CSA DNV
Vibrasjonsmotstand	5 gn (f= 2...500 Hz) i samsvar med IEC 60068-2-6
Støtmotstand	30 gn (varighet = 18 ms) for halv sinus kurve akselerasjon i samsvar med IEC 60068-2-27 50 gn (varighet = 11 ms) for halv sinus kurve akselerasjon i samsvar med IEC 60068-2-27

Forpakkingsinformasjon

Enhetstype pakke 1	PCE
Antall enheter i pakke 1	1
Pakke 1 Høyde	3,5 cm
Pakke 1 Bredde	4,5 cm
Pakke 1 Vekt	5,0 cm
Package 1 Weight	21,0 g
Enhetstype pakke 2	S01
Antall enheter i pakke 2	75
Pakke 2 Høyde	15,0 cm
Pakke 2 Bredde	15,0 cm
Pakke 2 Lengde	40,0 cm
Pakke 2 Vekt	1,725 kg

Bærekraftig

Produktets miljøstatus	Green Premium miljømerket produkt
REACH-regelverk	REACH-erklæring
REACH fri for SVHC	Ja
EU RoHS-direktiv	Proaktivt i samsvar (Produktet inngår ikke i EUs RoHS direktivet) EU RoHS-erklæring
Kvikksølvfri	Ja
Informasjon om RoHS-unntak	Ja
Kinas RoHS-forskrift	Kinas RoHS-Erklæring
Miljøinformasjon	Produktmiljøprofil
Produktets livssyklus	Informasjon Om Levetidsslutt

Garantiperiode

Garanti	18 months
---------	-----------

Dimensions

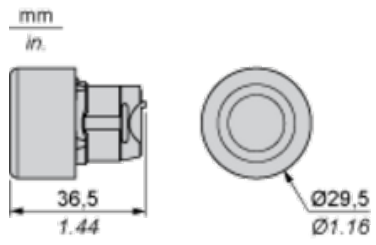

Panel Cut-out for Pushbuttons, Switches and Pilot Lights (Finished Holes, Ready for Installation)

Connection by Screw Clamp Terminals or Plug-in Connectors or on Printed Circuit Board

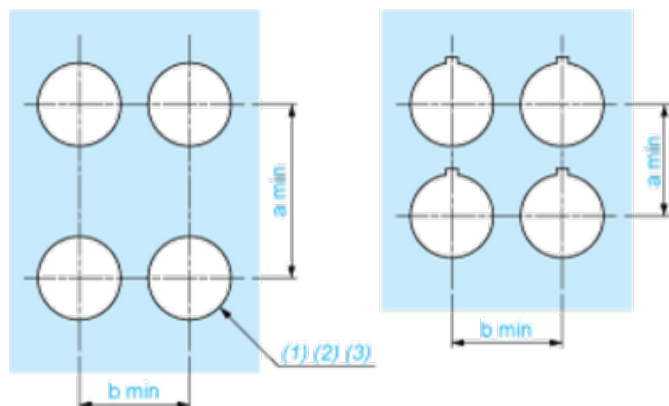

- (1) Diameter on finished panel or support
- (2) For selector switches and Emergency stop buttons, use of an anti-rotation plate type ZB5AZ902 is recommended.
- (3) $\varnothing 22.5$ mm recommended ($\varnothing 22.3_0^{+0.4}$) / $\varnothing 0.89$ in. recommended ($\varnothing 0.88$ in. $_0^{+0.016}$)

Connections	a in mm	a in in.	b in mm	b in in.
By screw clamp terminals or plug-in connector	40	1.57	30	1.18
By Faston connectors	45	1.77	32	1.26
On printed circuit board	30	1.18	30	1.18

Detail of Lug Recess

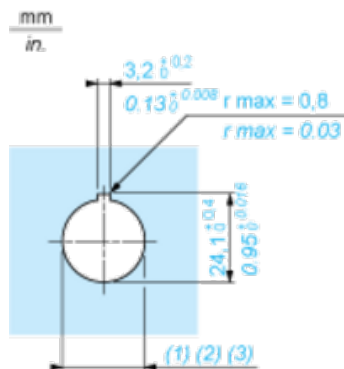

- (1) Diameter on finished panel or support
- (2) For selector switches and Emergency stop buttons, use of an anti-rotation plate type ZB5AZ902 is recommended.
- (3) $\varnothing 22.5$ mm recommended ($\varnothing 22.3_0^{+0.4}$) / $\varnothing 0.89$ in. recommended ($\varnothing 0.88$ in. $_0^{+0.016}$)

Pushbuttons, Switches and Pilot Lights for Printed Circuit Board Connection

Panel Cut-outs (Viewed from Installer's Side)



A: 30 mm min. / 1.18 in. min.

B: 40 mm min. / 1.57 in. min.

Printed Circuit Board Cut-outs (Viewed from Electrical Block Side)

Dimensions in mm



A: 30 mm min.

B: 40 mm min.

Dimensions in in.

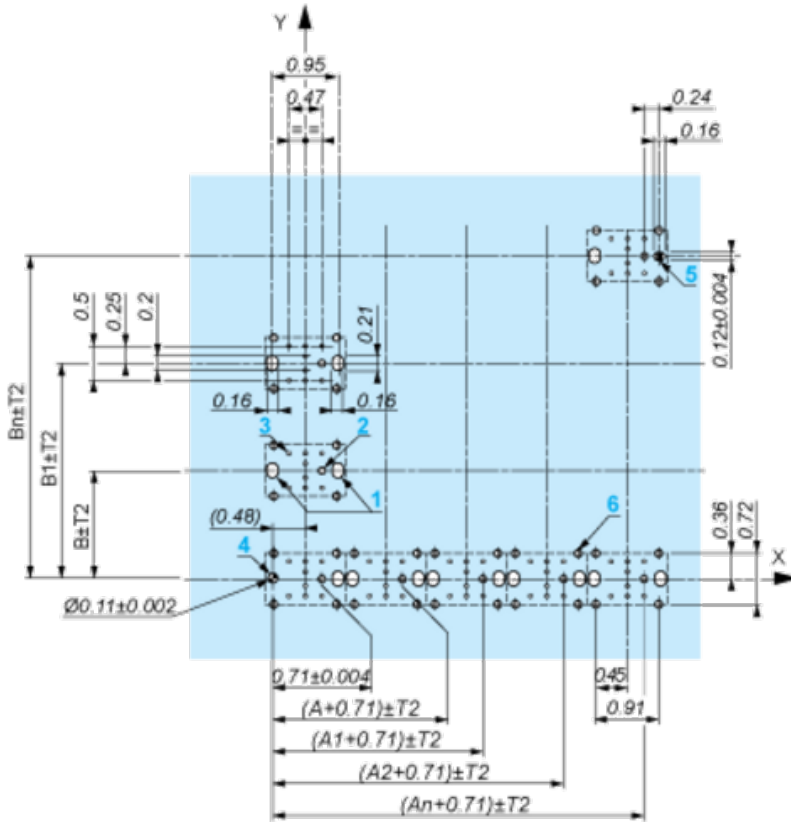

A: 1.18 in. min.
 B: 1.57 in. min.

General Tolerances of the Panel and Printed Circuit Board

The cumulative tolerance must not exceed 0.3 mm / 0.012 in.: $T1 + T2 = 0.3 \text{ mm max.}$

Installation Precautions

- Minimum thickness of circuit board: 1.6 mm / 0.06 in.
- Cut-out diameter: 22.4 mm \pm 0.1 / 0.88 in. \pm 0.004
- Orientation of body/fixing collar ZB5AZ009: $\pm 2^\circ 30'$ (excluding cut-outs marked a and b).
- Tightening torque of screws ZBZ006: 0.6 N.m (5.3 lbf.in) max.
- Allow for one ZB5AZ079 fixing collar/pillar and its fixing screws:
 - every 90 mm / 3.54 in. horizontally (X), and 120 mm / 4.72 in. vertically (Y).
 - with each selector switch head (ZB5AD•, ZB5AJ•, ZB5AG•).

The fixing centers marked a and b are diagonally opposed and must align with those marked 4 and 5.



- (1) Head ZB5AD•
 (2) Panel
 (2) Nut

(4) Printed circuit board

Mounting of Adapter (Socket) ZBZ01•

- 1 2 elongated holes for ZBZ006 screw access
- 2 1 hole \varnothing 2.4 mm \pm 0.05 / 0.09 in. \pm 0.002 for centring adapter ZBZ01•
- 3 8 \times \varnothing 1.2 mm / 0.05 in. holes
- 4 1 hole \varnothing 2.9 mm \pm 0.05 / 0.11 in. \pm 0.002, for aligning the printed circuit board (with cut-out marked a)
- 5 1 elongated hole for aligning the printed circuit board (with cut-out marked b)
- 6 4 holes \varnothing 2.4 mm / 0.09 in. for clipping in adapter ZBZ01•

Dimensions An + 18.1 relate to the \varnothing 2.4 mm \pm 0.05 / 0.09 in. \pm 0.002 holes for centring adapter ZBZ01•.

Electrical Composition Corresponding to Codes M1 and M7

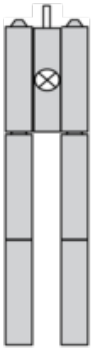

Electrical Composition Corresponding to Codes M2 and M8

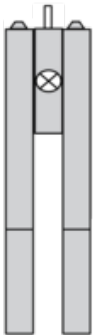

Electrical Composition Corresponding to Codes M6 and P2

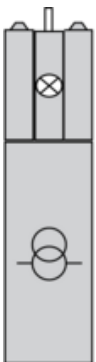

Electrical Composition Corresponding to Codes M5, M10, MF1, MR1 and MF2

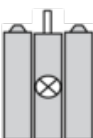

Legend

Single contact

Double contact

Light block

Possible location

