

# XUM0APSA5

Photoelectric sensors XU, XUM, multi, Sn  
0...10 m, 12...24 VDC, cable 5 m



## Main

Range of product	Telemecanique Photoelectric sensors XU
Series name	General purpose multimode
Electronic sensor type	Photo-electric sensor
Sensor name	XUM
Sensor design	Miniature
Detection system	Multimode
Material	Plastic
Type of output signal	Discrete
Supply circuit type	DC
Wiring technique	3-wire
Discrete output type	PNP
Discrete output function	1 NO or 1 NC programmable
Electrical connection	Cable
Cable length	5 m
Product specific application	-
Emission	Infrared diffuse Infrared diffuse with background suppression Infrared thru beam Red polarised reflex
[Sn] nominal sensing distance	3 M polarised reflex need reflector XUZC50 10 M thru beam need a transmitter XUM0AKSAL5T 0.1 M diffuse with background suppression 0.4 m diffuse

## Complementary

Enclosure material	PBT
Lens material	PMMA
Maximum sensing distance	14 M thru beam 4 M polarised reflex 0.1 M diffuse with background suppression 0.55 m diffuse
Output type	Solid state
Add on output	With alarm output, 50 mA
Wire insulation material	PvR
Status LED	1 LED (green) for supply 1 LED (red) for instability 1 LED (yellow) for output state
[Us] rated supply voltage	12...24 V DC with reverse polarity protection
Switching capacity in mA	<= 100 mA (overload and short-circuit protection)
Switching frequency	<= 250 Hz
Maximum voltage drop	<1.5 V (closed state)
Current consumption	35 mA no-load
Maximum delay first up	100 ms
Maximum delay response	2 ms
Maximum delay recovery	2 ms
Setting-up	Self-teaching
Depth	20 mm
Height	34 mm
Width	12 mm

## Environment

Product certifications	CE[RETURN]CSA[RETURN]UL
Ambient air temperature for operation	-25...55 °C
Ambient air temperature for storage	-40...70 °C
Vibration resistance	7 gn, amplitude = +/- 1.5 mm (f = 10...55 Hz) conforming to IEC 60068-2-6
Shock resistance	30 gn (duration = 11 ms) conforming to IEC 60068-2-27
IP degree of protection	IP65 double insulation conforming to IEC 60529 IP67 double insulation conforming to IEC 60529

## Packing Units

Unit Type of Package 1	PCE
Number of Units in Package 1	1
Package 1 Height	4.2 cm
Package 1 Width	9.7 cm
Package 1 Length	13.2 cm
Package 1 Weight	173.0 g
Unit Type of Package 2	S02
Number of Units in Package 2	24
Package 2 Height	15 cm
Package 2 Width	30 cm
Package 2 Length	40 cm
Package 2 Weight	4.908 kg
Unit Type of Package 3	P06
Number of Units in Package 3	384
Package 3 Height	75 cm
Package 3 Width	40 cm
Package 3 Length	80 cm
Package 3 Weight	91.432 kg

## Offer Sustainability

Sustainable offer status	Green Premium product
California proposition 65	WARNING: This product can expose you to chemicals including: Diisononyl phthalate (DINP), which is known to the State of California to cause cancer, and Di-isodecyl phthalate (DIDP), which is known to the State of California to cause birth defects or other reproductive harm. For more information go to <a href="http://www.P65Warnings.ca.gov">www.P65Warnings.ca.gov</a>
For all Reach Rohs enquiries contact us at	<a href="mailto:sustainability@tesensors.com">sustainability@tesensors.com</a>

## Contractual warranty

Warranty	18 months
----------	-----------

## Dimensions

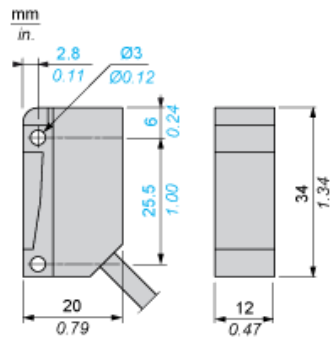

---

## Wiring Schemes

---

### Receiver, PNP Output

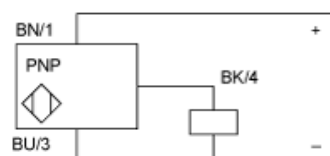

BN : Brown  
BU : Blue  
BK : Black

Detection Curves

With Thru-beam Accessory (Thru-beam)

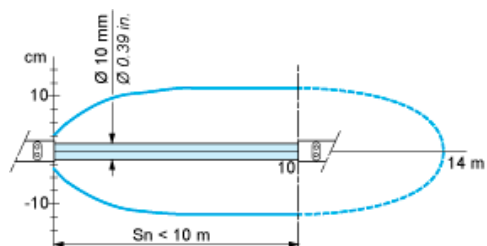

Without Accessory (Diffuse)

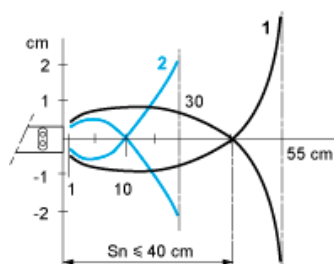

1 : White 90%  
2 : Grey 18%  
Object 10 x 10 cm

Without Accessory (Diffuse with background suppression)

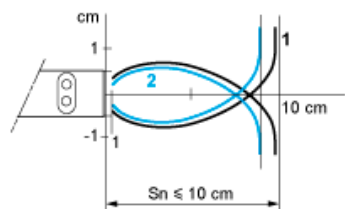

1 : White 90%  
2 : Grey 18%  
Object 10 x 10 cm

With reflector (Polarised reflex)

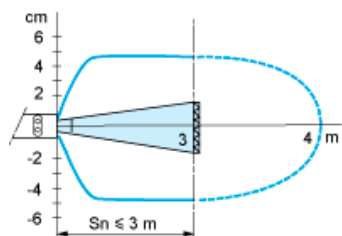

With reflector XU5C50

## Variation of Usable Sensing Distance $S_u$ (Without accessory, with adjustable background suppression)

Teach Mode at Minimum

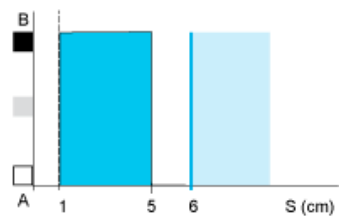

Teach Mode at Maximum

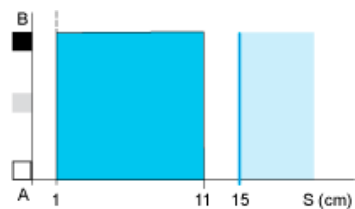

- (1) Black
- (2) Grey
- (3) White
- (4) Sensing range
- (5) Non sensing zone (matt surfaces)

A-B : Object reflection coefficient

- (1) Black 6%
- (2) Grey 18%
- (3) White 90%
- (4) Sensing range
- (5) Non sensing zone (matt surfaces)